

UT2024-009

Description:

Common-mode coils are useful in a wide range of applications for the prevention of electromagnetic interference (EMI) and radio frequency interference (RFI) from power supply lines and for prevention of malfunctioning of various electronic equipments. Features include low leakage flux, high self-resonant frequency, high impedance at applicable frequency and low stray capacitance in section winding. Designed to meet UL, CSA and IEC standards.

Electrical Specifications (@20°C):

Min. Inductance* (mH)	Inductance Difference (µH) Max	Max. DC (Ω) Resistance	Amps RMS
1.10	150	0.25	0.90

*inductance per winding.

Specifications:

Rated Voltage = 250VAC
 Temperature Rise = 45°C Max
 Insulation Resistance = 100M Ω Min
 Operating Temperature Range = -20 to 105°C
 Dielectric Withstanding Voltage = 2,000 VAC

Dimensions:

W	L	H	A	B
.905	.728	.925	.512	.394

Units in inches

Weight: .52 oz.

Schematic:

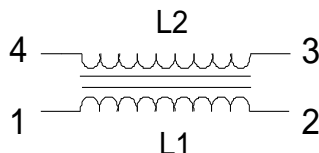

RoHS Compliance: As of manufacturing date February 2016, all standard products meet the requirements of 2015/863/EU, known as the RoHS 3 initiative.

*Upon printing, this document is considered "uncontrolled". Please contact Triad Magnetics website for the most current version. For soldering and washing information please see <http://www.triadmagnetics.com/faq.html>

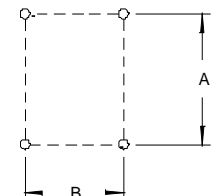
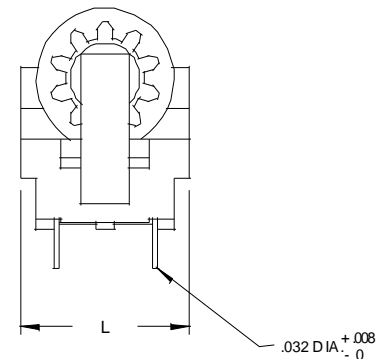
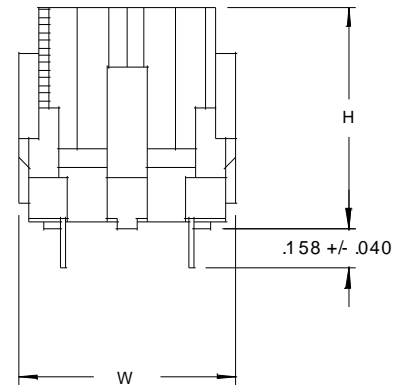
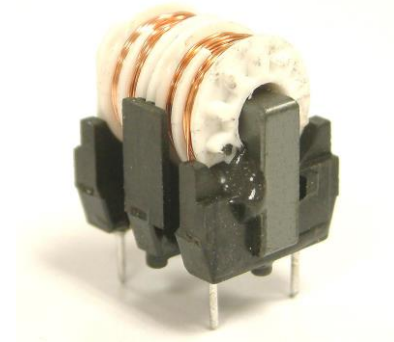

PIN MOUNTING